

1. The list of parts and materials to build:

Accessory kit:

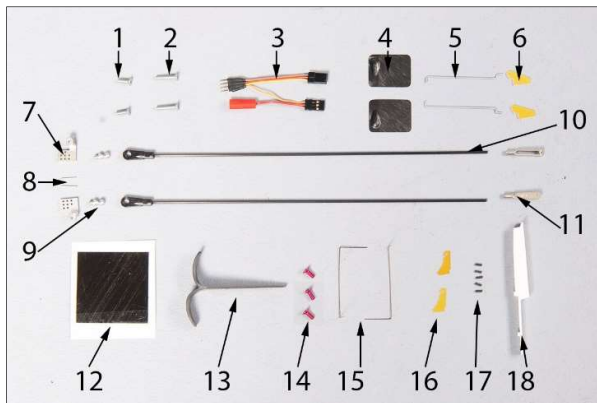

Parts set:



1. Rear short screws for fixing wing (M3x10 , 1 spare screw);
2. Forward long screws for fixing wing (M3x14, 1 spare screw);
3. Fuselage part of the wire for aileron servos with JST battery connector;
4. Yoda aileron servo hatches (left and right);
5. Yoda aileron rods (2pcs);
6. Yoda aileron horns (2 pcs);
7. Yoda aluminum flap horns (Snipe 2 aileron horns) (left and right);
8. Aileron horn pins (D1x10, 2 pcs);
9. Yoda (Snipe 2) Ball link screws; (2 pcs);
10. Yoda aileron rods (2 pcs);
11. Aileron clevises (with M2.5 thread);
12. Carboline SC 78 4/30 carbon for fixing aileron pins(1 pcs; 50x50 mm);
13. Yoda (Snipe 2) wing throwing peg;
14. Stabilizer fixing screws (M3x8, Aluminum, 1 pc spare);
15. Elevator and rudder torsion springs;
16. Elevator and rudder control horns;
17. Pipes for the fixing control cables (1 spare);
18. Yoda (Snipe 2) ballast fixing part;

1. Yoda wing;
2. Yoda fuselage;
3. Yoda (Snipe 2) horizontal stabilizer;
4. Yoda vertical stabilizer;
5. Yoda nose cone;
6. Yoda accessoires kit;

The list of materials needed to build the model:

- | | |
|---|-----------------------------|
| 1) Superglue and liquid medium, the accelerator | 4) Pen and ruler |
| 2) Cutter | 5) Pliers |
| 3) Masking tape | 6) Sandpaper number 240-320 |

2. Assembling the model

2.1 Flap horns installation.

This is very important sequence to follow for successful control installation.



Place a small piece of tape on bottom of flap over control horn and make small hole in flap with pin for glue hole.

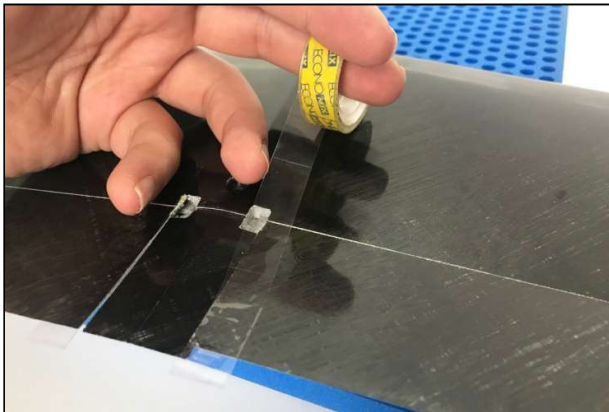

CAUTION!
Gluing zone of aluminium horn is covered with primer for epoxy and CA!

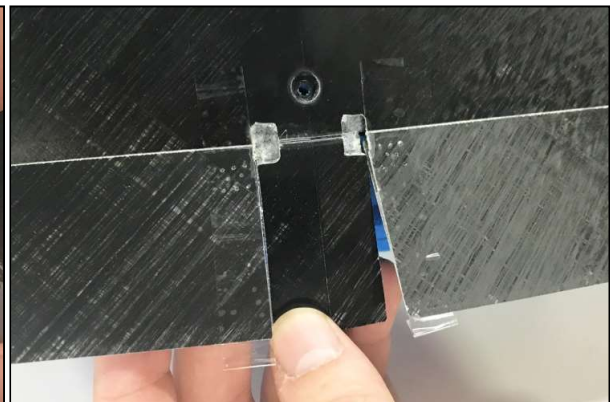
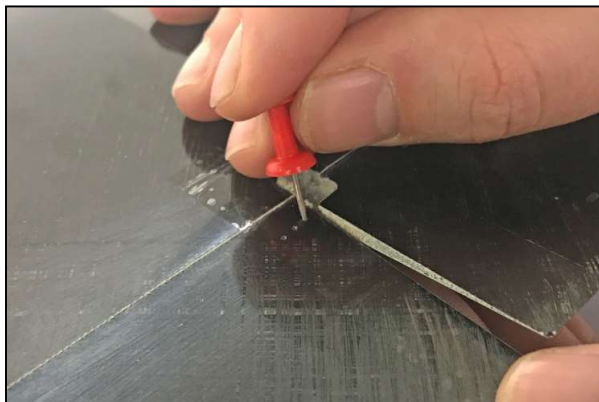

Glue pins in groves at bottom of wing.

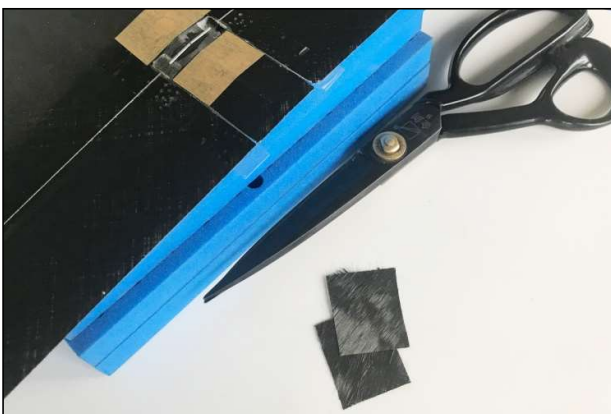
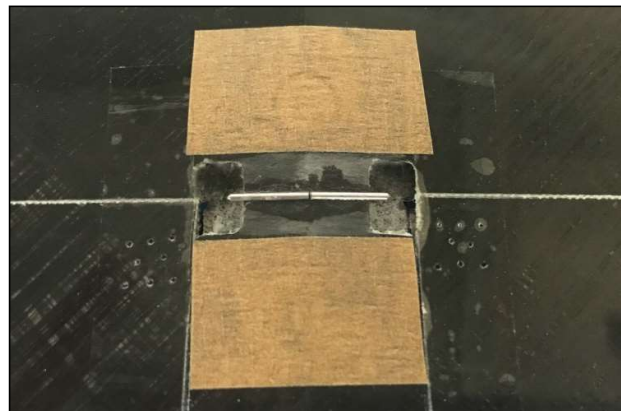
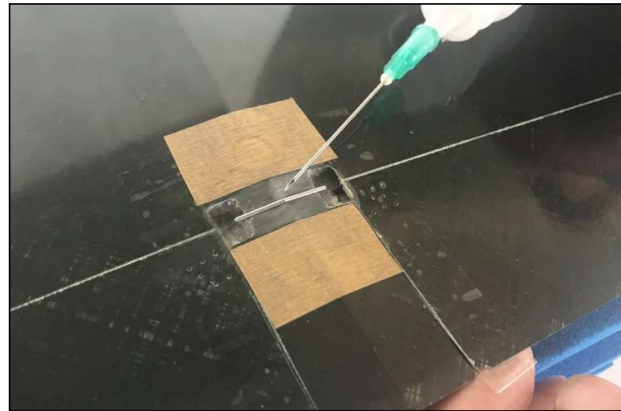
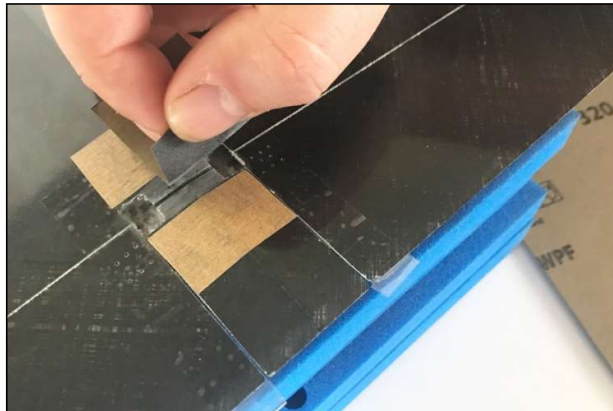
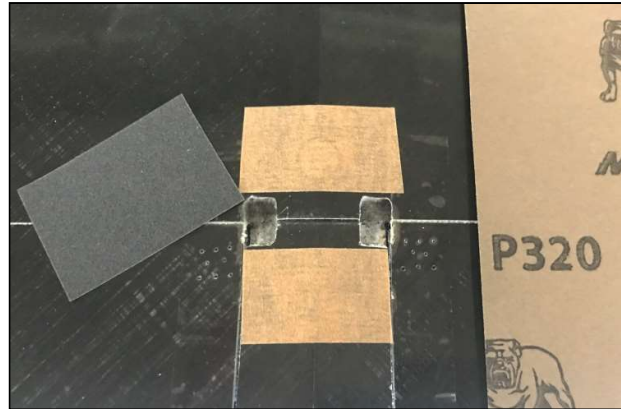
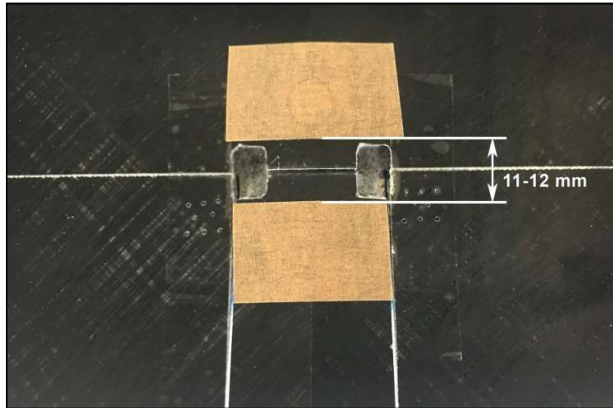

Reinforce aileron's pins by 2-3 layers of Carbolite SC 39 2/45 (8x14 mm).

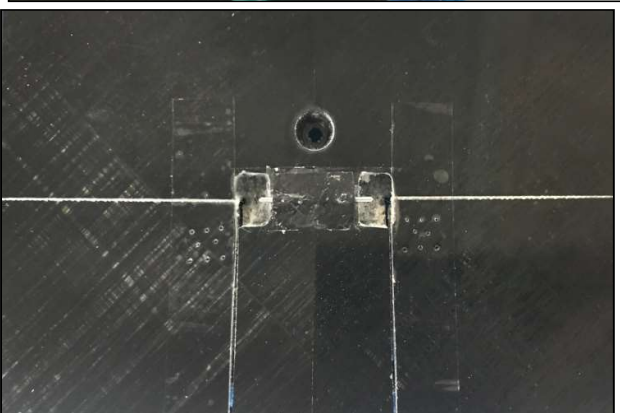
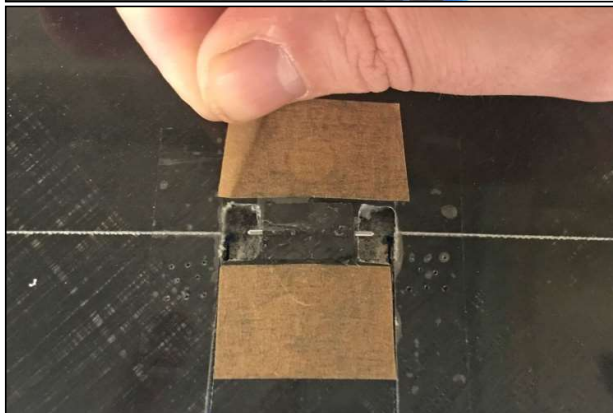
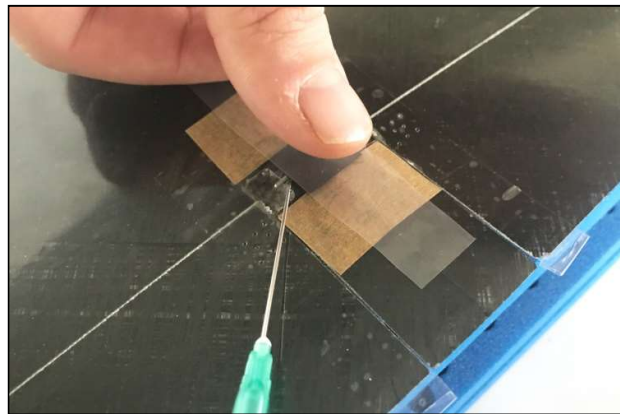
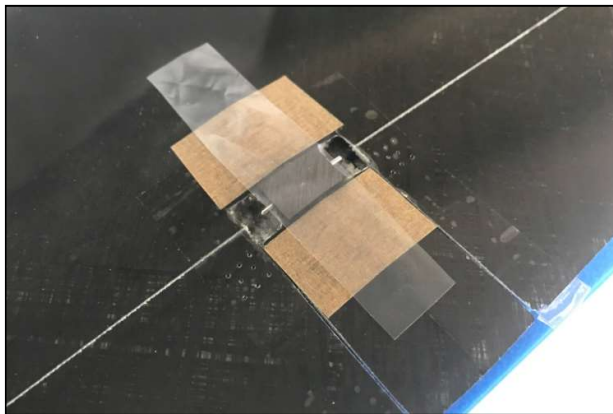
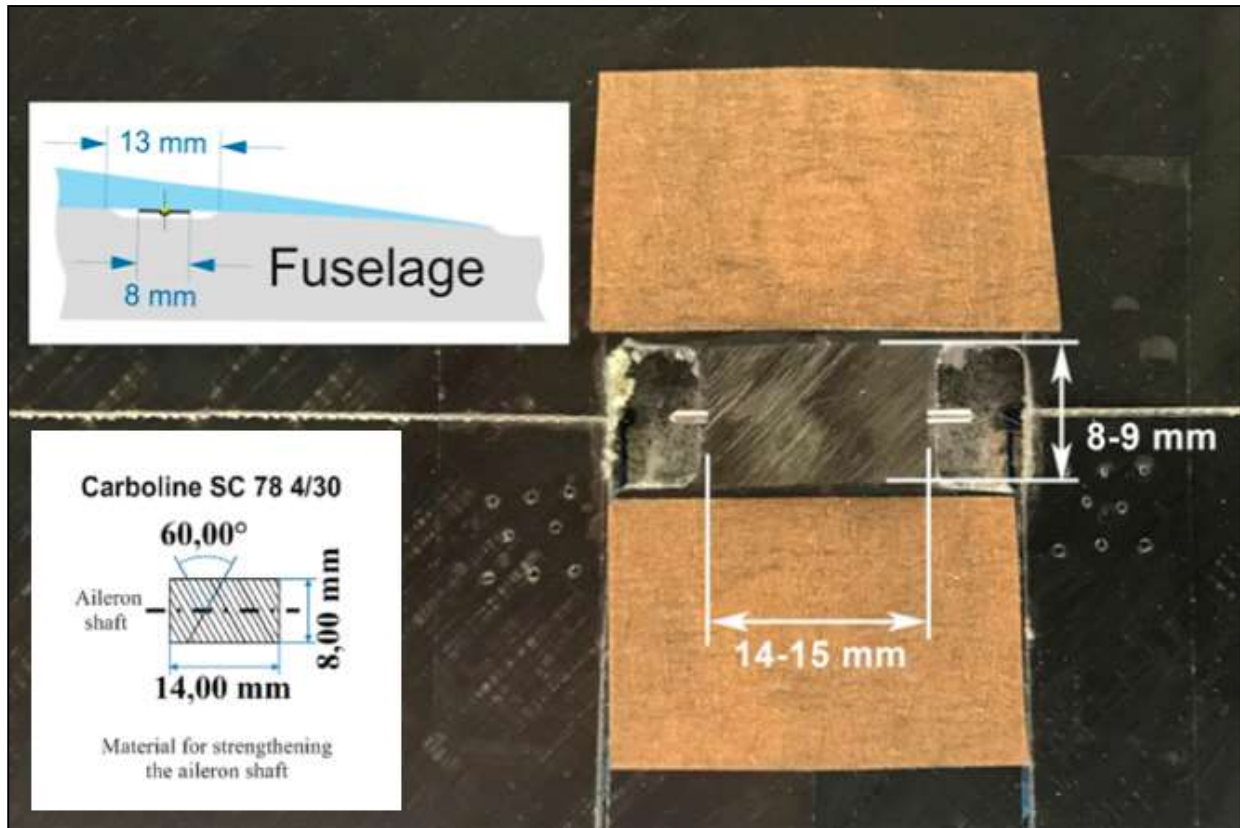

YODA

Recommendations for assembly

Then slide control horn into slot in flap. Next, slide control horn on pin and push horn to inside edge of hole, toward center of wing. Leave just enough clearance between horn and hole so the horn does not scrape edge of hole.

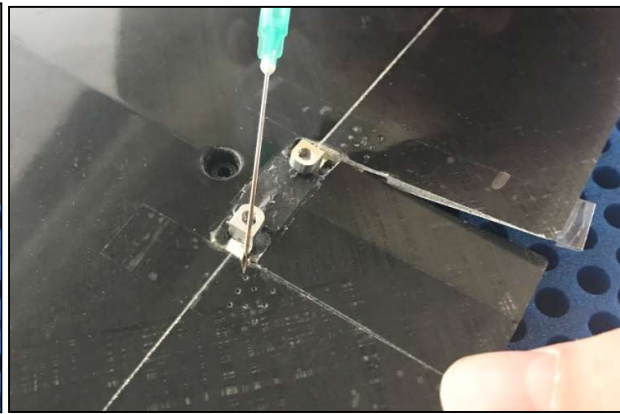
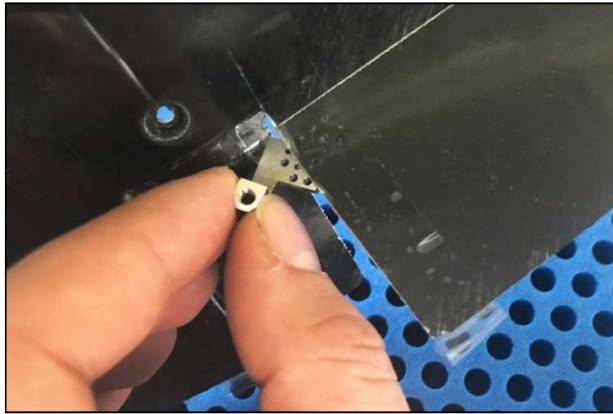

Use some thin CA and drip glue into pin hole. When CA is dry, remove tape. Pull flap down and fill space around control horn with CA.

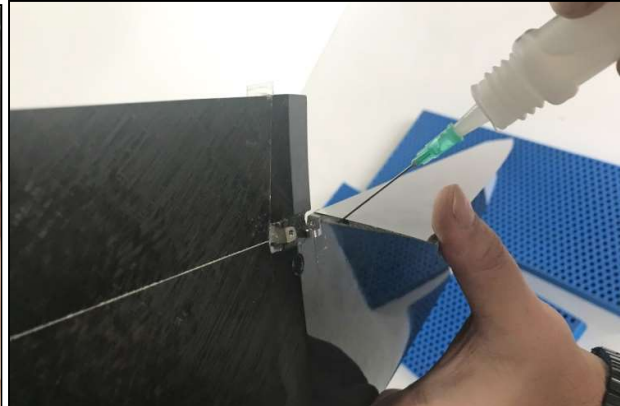

2.2 Yoda aileron servo and horn installation.

You must insert the rod from the outside of the wing and rotate it 90 degrees.

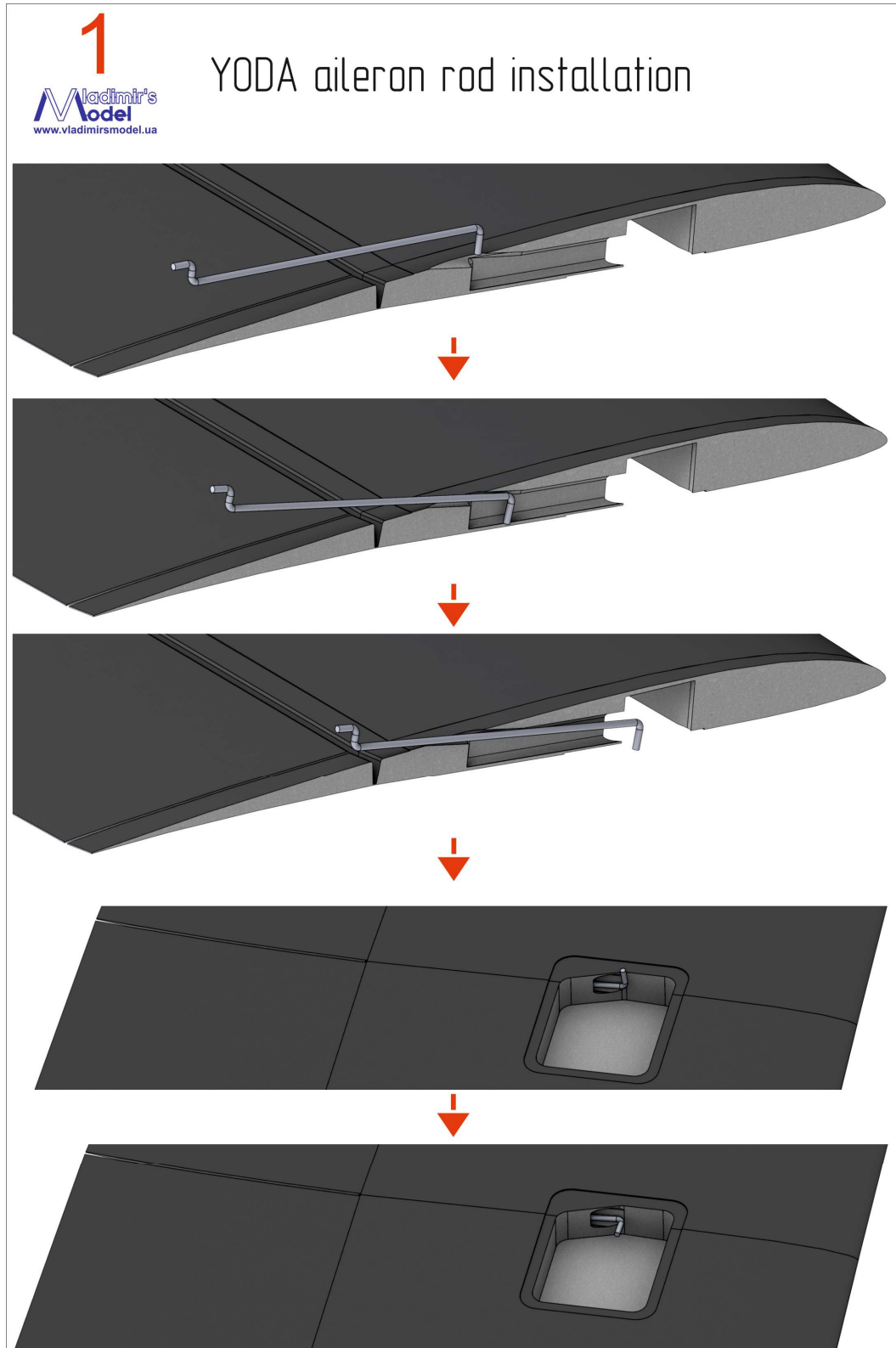

YODA

Recommendations for assembly

Drill a 1mm hole as close as possible to the base of the servo horn and cut the horn to the minimum size.
In the middle position of the servo, install the horn at an angle of 90 degrees to the servo.
Spread epoxy on the sides of the servos and the sides of servo spot.
Put the servo horn to the rod and insert the servo into the place.
It is necessary to fix the servo until the resin cures with thick super glue.

2 YODA aileron KST x06 servo installation
(with minimum aileron horn arm 3.8 mm)



you have to make new hole $\varnothing 1\text{mm}$

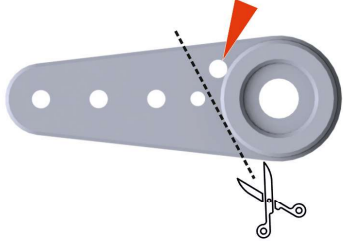

90°

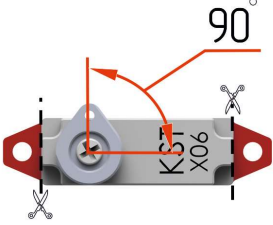

5 min epoxy

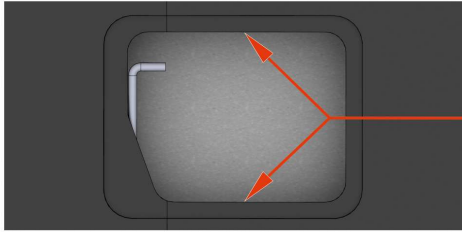

Servo tester: PWM 1500ms

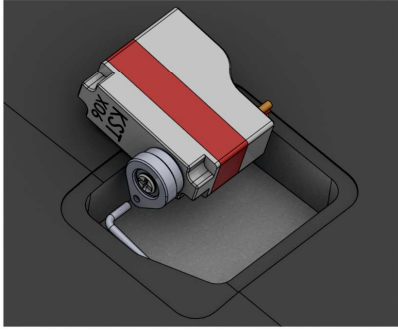

5 min epoxy

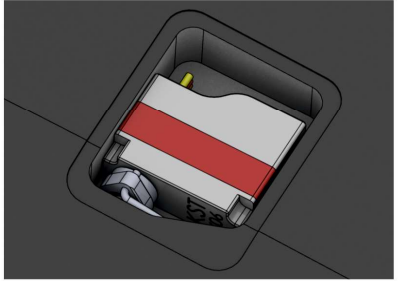
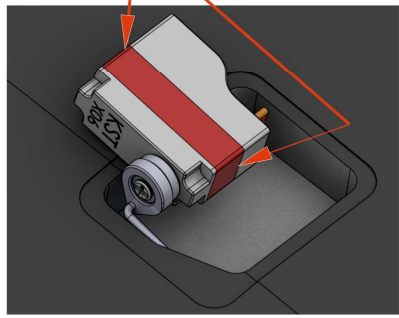

solder wires according to colors

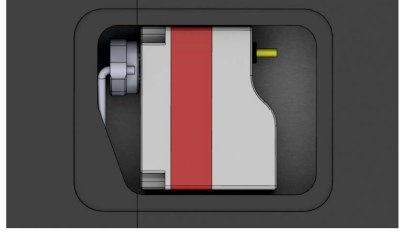

After resin polymerization, put on the aileron horn to the rod. Set the neutral position of the servo and aileron and fix the horn in the aileron with thin superglue in this neutral position.

3

Vladimir's
Model
www.vladimirmodel.ua

YODA aileron horn installation

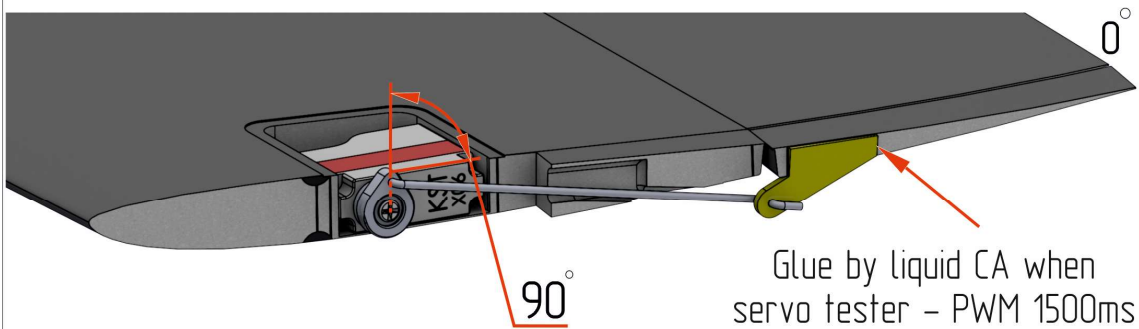
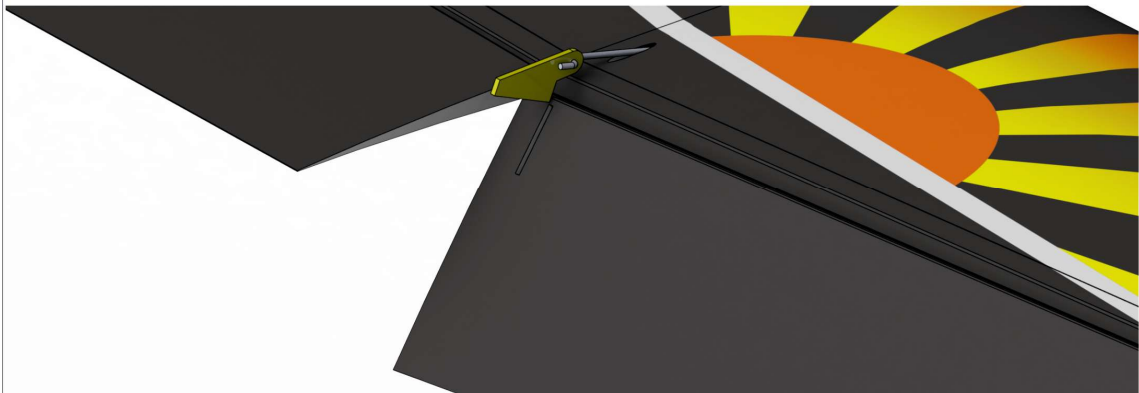
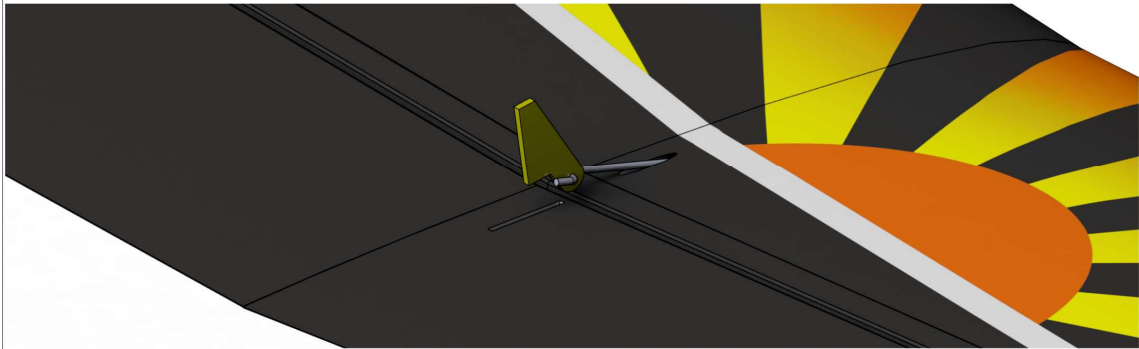

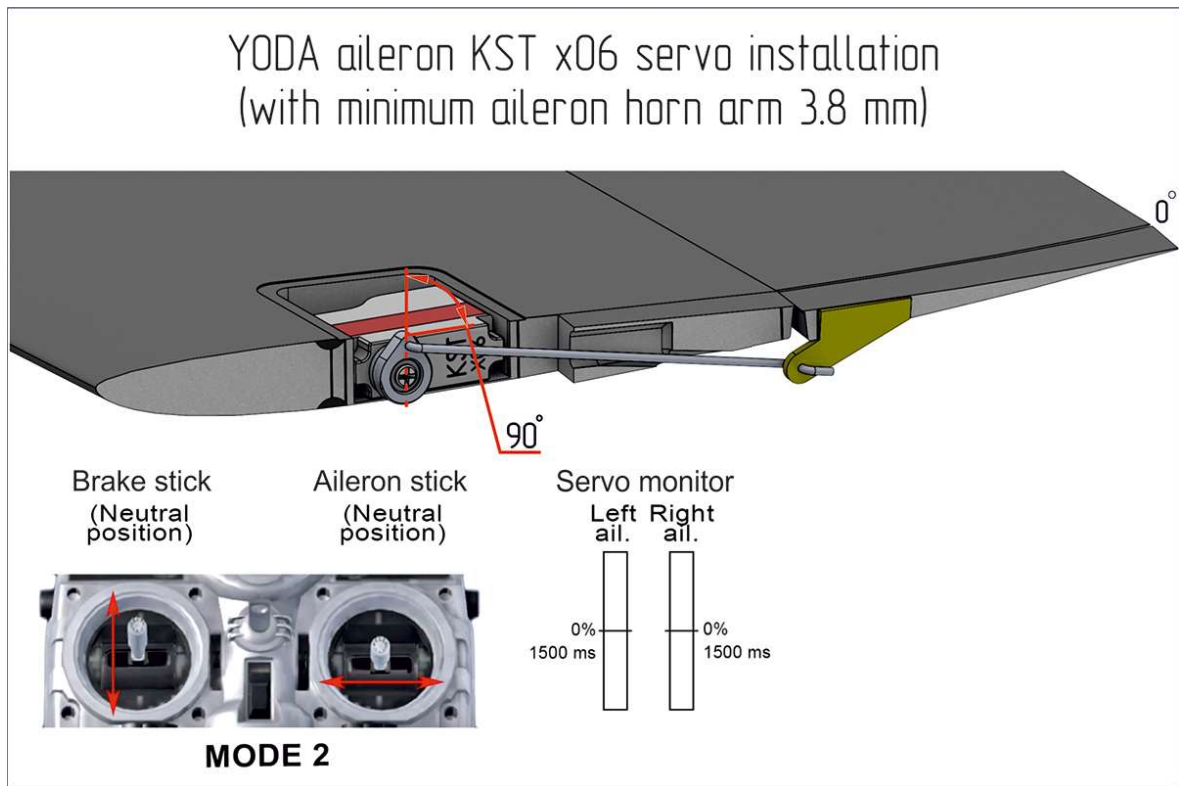

2.3 Launching peg installation.

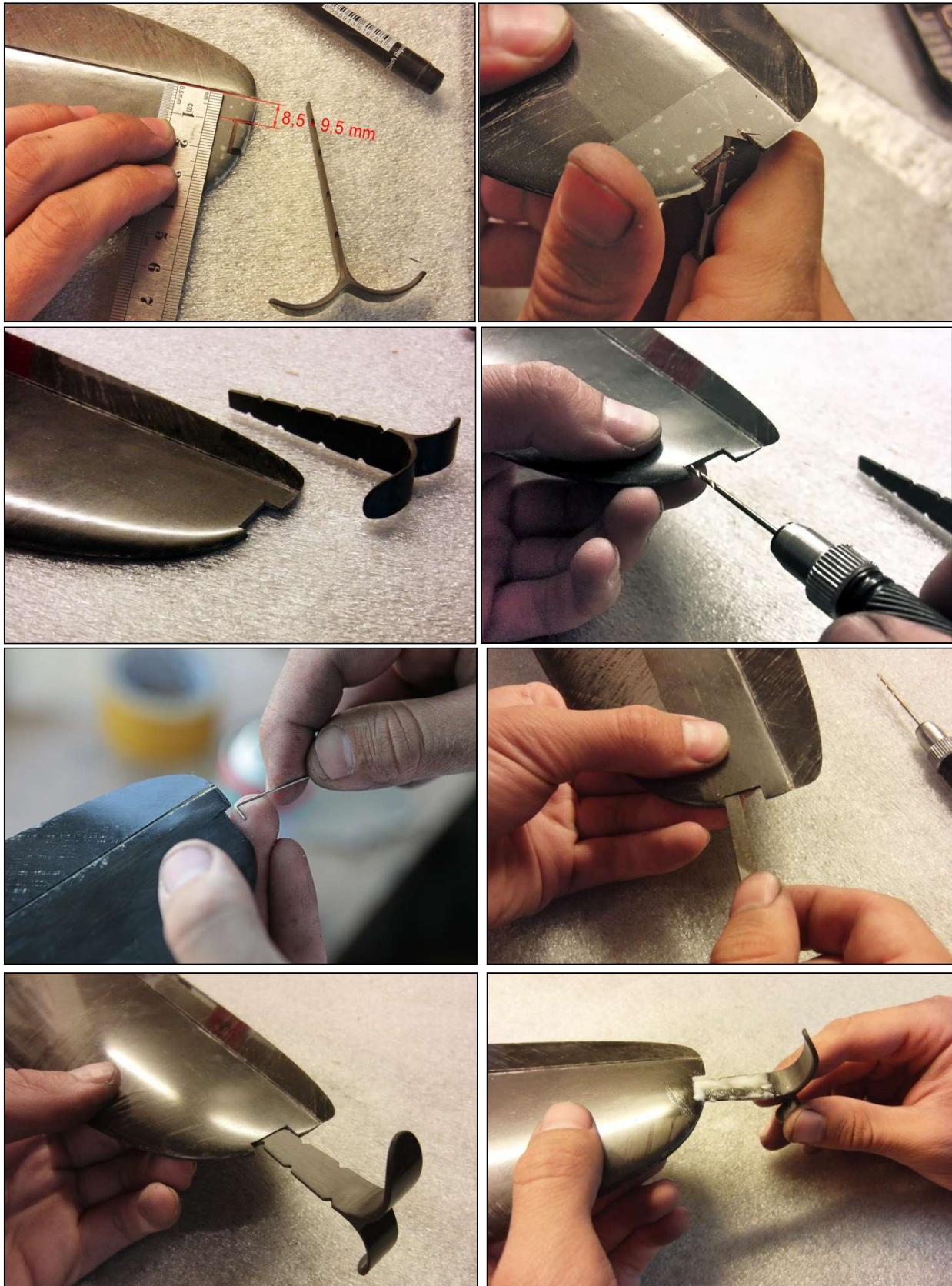



Please rewind the base of throwing peg by Kevlar thread to avoid peg delamination, like fig.

2.4 Fuselage servo accomodation.



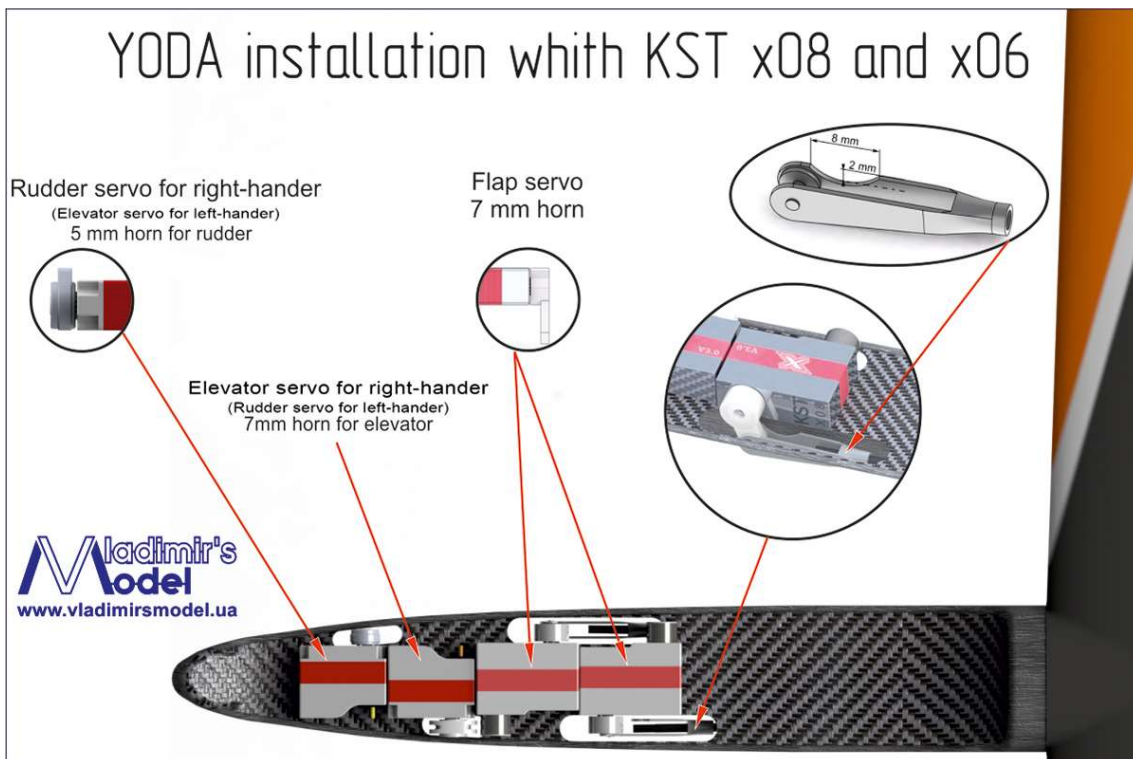
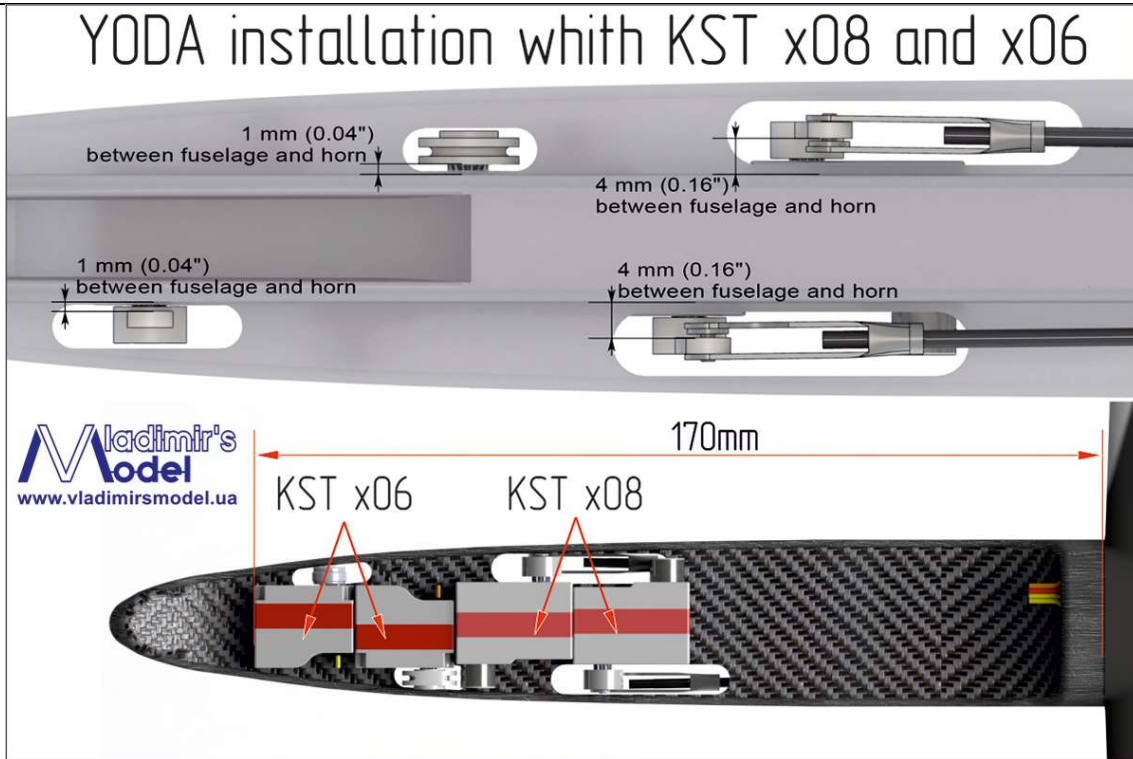

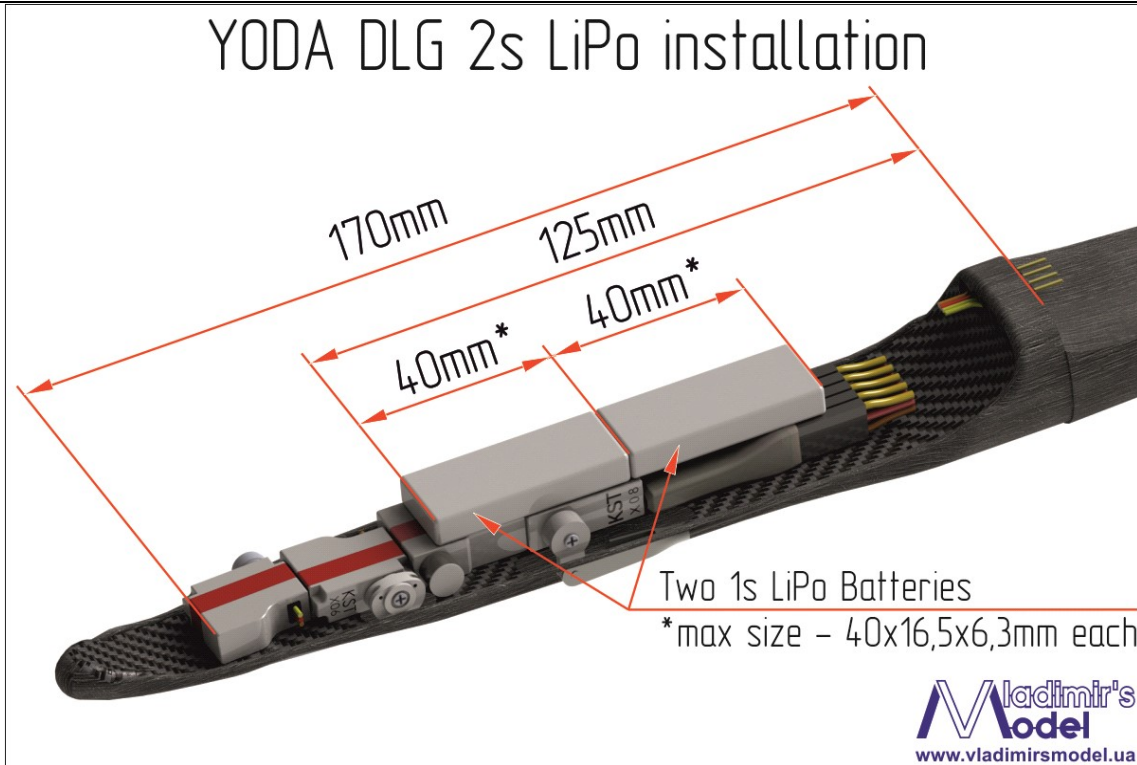

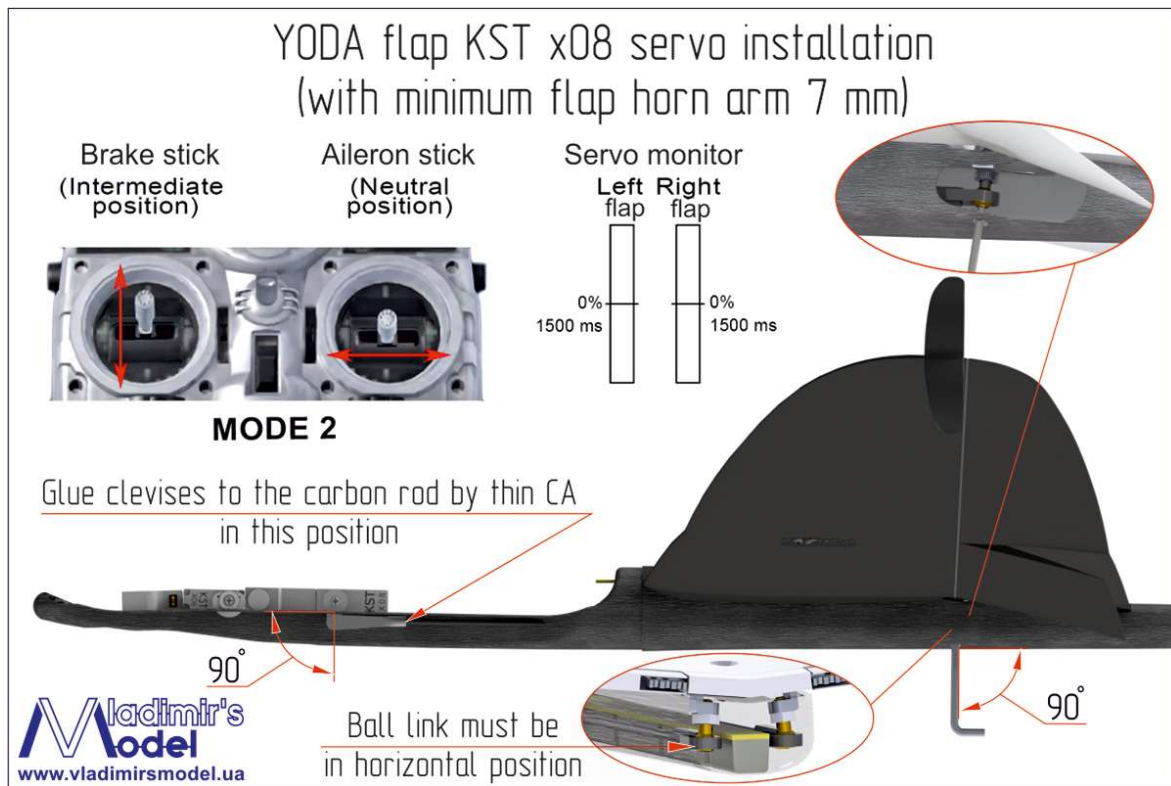

- The flaps have the same horns as in Snipe 2. ball head screws are screwed through the holes in the fuselage with a 2.5 mm wrench. Use wrench without sphere.
- To screw the horn, you need to turn the flap down 18 degrees.
- We have to fix wing by two M3 screw: the longer screw for front and shorter to the back side.

2.5 Rudder and Elevator installation.

With a knife cut the slots in the elevator and rudder in these locations. (Fig. 2.1 - 2.2).

Elevator horn is exactly in the center (along the axis of the stabilizer mounting holes) as the position must coincide with the slot in the pylon and tail boom. Horns must be glued full depth to elevator.

Liquid superglue Glue Horns in elevator and rudder..

Note:

- the maximum height of the elevator horn is 15 mm (Fig. 2.3)

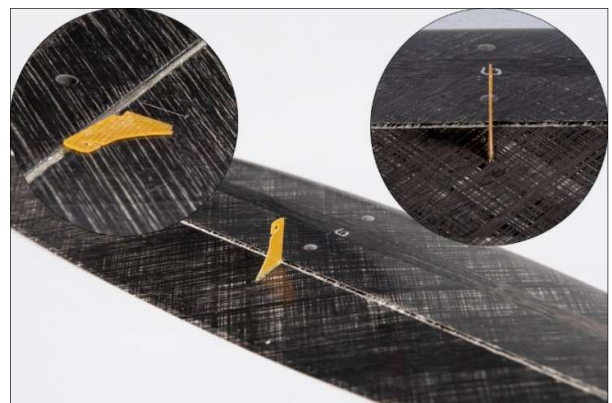

Figure 2.1 - Bonding elevator horn

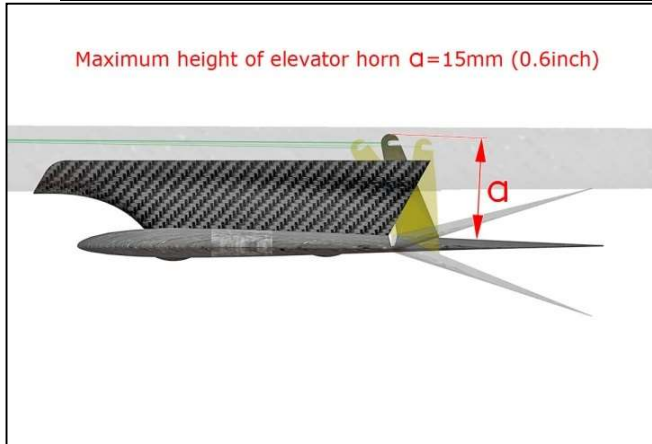

Figure 2.3 - Maximum elevator horn length



Figure 2.2 – rudder horn installation location

Bonding of torsion spring in the control surfaces

Center torsion spring on the control surface. (Fig. 2.4)

Make holes for the torsion spring with a needle and install torsion spring with superglue. (Fig. 2.5, 2.6) Torsion spring should provide force to the opposite side of the control horn.

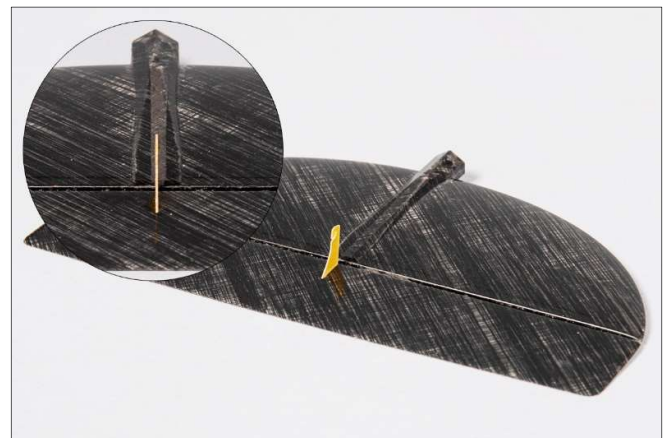

Figure 2.4-Torsion spring location

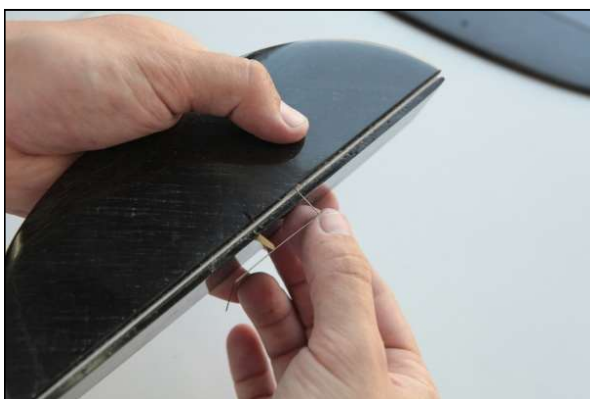

Figure 2.5 - Insert the torsion bar in the tail

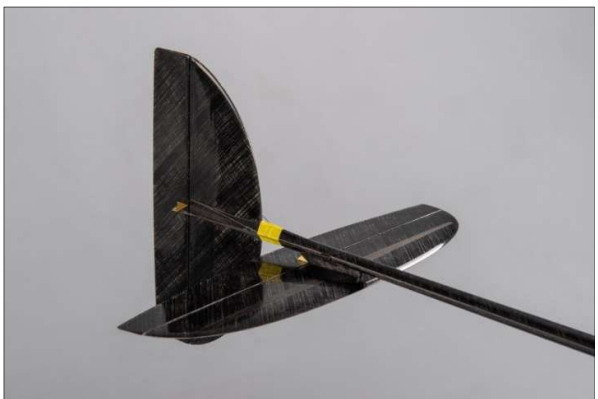
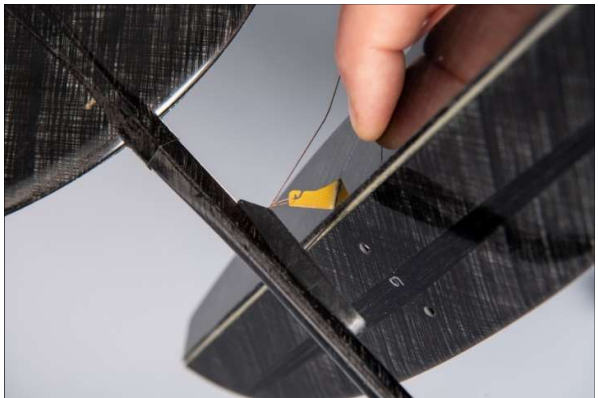
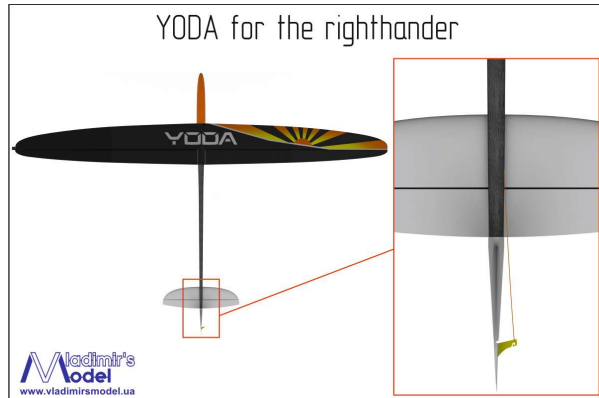
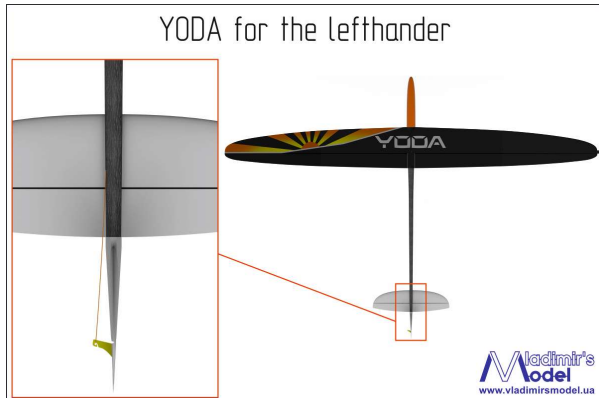

Figure 2.6 - Sizing torsion feathers

2.6 Yoda Fin installation.

Yoda fin is removable now. It is the same for left and right hander because the Yoda fin is symmetrical.

Important: Put on Yoda fin to the fuselage until stop and fix it by tape before flight!



ATTENTION:
You must put on the fin to the fuselage until it stops
and fixed with tape.
Masking tape will do.

2.7 Rudder and Elevator control cables.

Insert the wire through the hole on the control horn. Using a tube for cables (which you'll find in the accessories kit) with a pair of pliers to crimp the cable as photo 2.11

To make a draft of the stabilizer of a cable loop and crimp its tube for fixing the rope. (Fig. 2.12).

For assistance in assembly, attach a 100 mm thread to the elevator cable. You can lock the thread on the tail boom with tape and pull it out of the slot in the fuselage for assembly of the model.

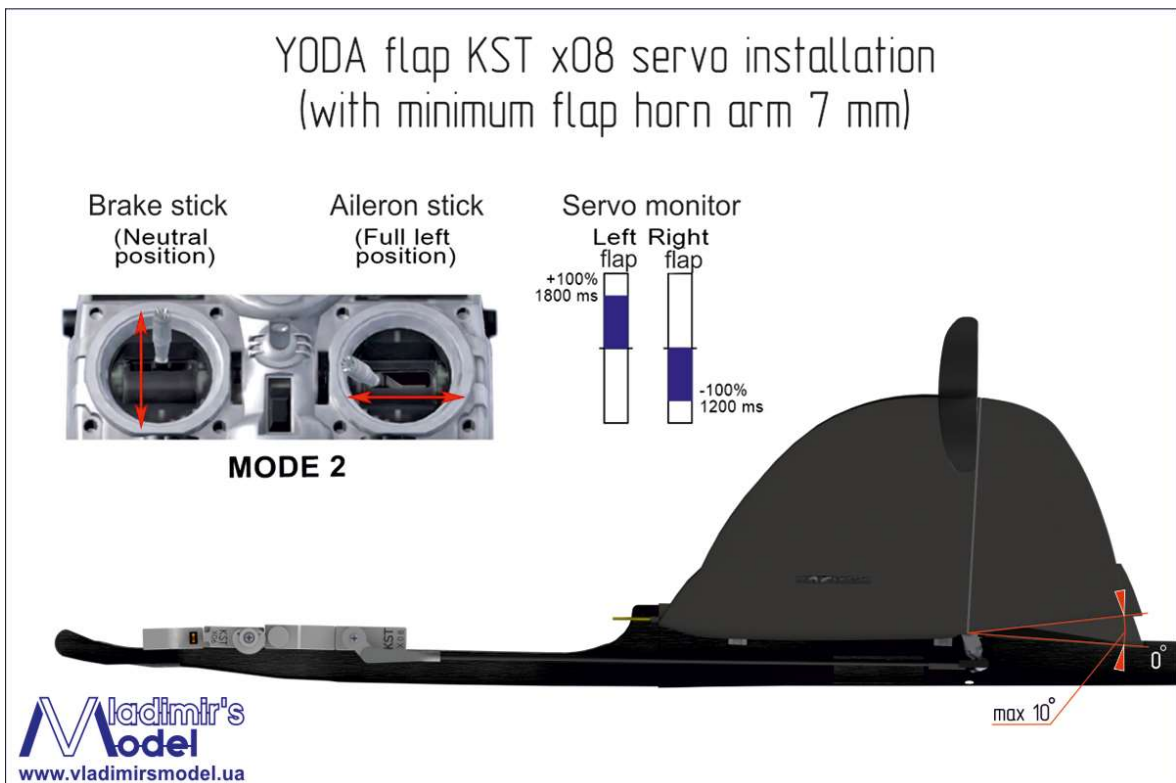
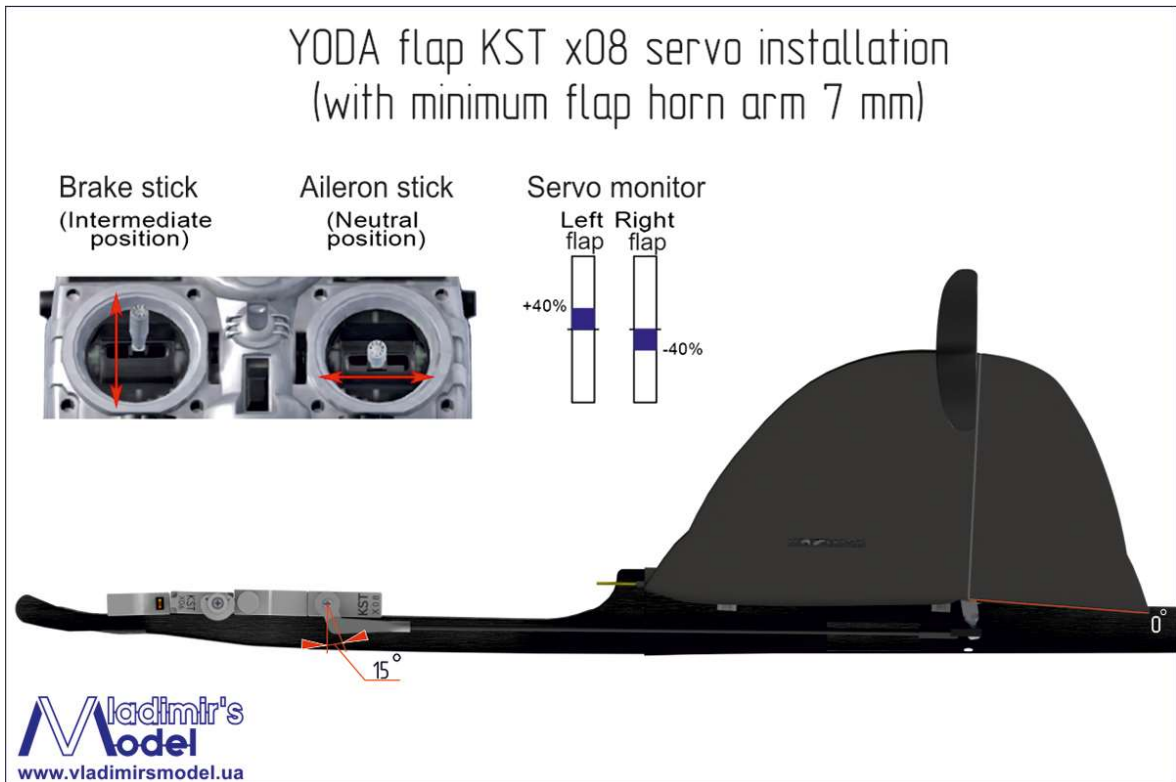

Figure 2.11 - Crimping tube cable



Figure 2.12 - Preparation for the cable stabilizer

3. Radio-control installation



YODA flap KST x08 servo installation (with minimum flap horn arm 7 mm)

Brake stick (Full brake position) Aileron stick (Neutral position)



MODE 2

Servo monitor

Left flap	Right flap
-125% 1000 ms	+125% 2000 ms

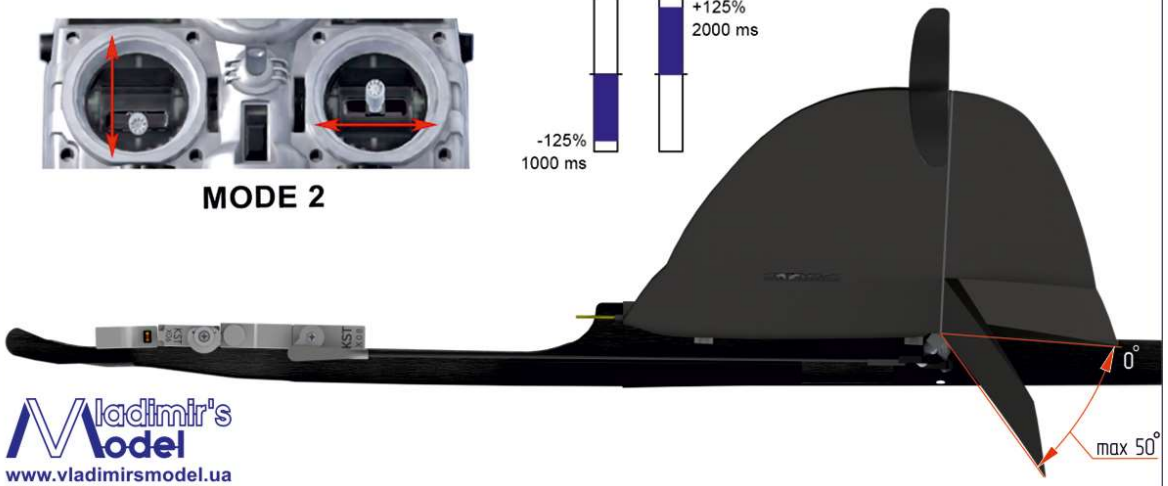
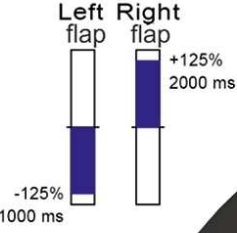

0°
max 50°

Vladimir's Model
www.vladimirsmodei.ua