

AerobTec Altis GPS

***Recording and telemetric GPS receiver
with integrated altimeter***



Manufacturer:
AerobTec, s.r.o.
Ilkovičova 3
841 04 Bratislava

www.aerobtec.com
info@aerobtec.com

Table of contents

1.Specifications.....	3
2.Introduction.....	3
3.How does it work.....	3
4.Hardware description.....	4
Connectors of your Altis GPS.....	4
Mounting to the aircraft.....	5
Connection.....	5
Connection for data logging only.....	5
Connection for telemetry.....	5
USB connection.....	6
Do not disconnect.....	6
5.Working with the Altis GPS in the Altis Flight manager.....	7
Altis GPS window.....	7
Downloading the data.....	8
Erasing data.....	8
Formating device.....	8
Reseting flight counter.....	8
Settings.....	8
Firmware upgrade.....	10
Firmware types.....	10
Backup firmware.....	10
Map View.....	11
Permanent elements.....	11
Optional elements.....	11
6.Warning.....	13
7.Frequently asked questions and troubleshooting.....	13
8.Correct disposal of this product.....	14
9.Product Registration.....	14
10.Notes.....	15
11.Revision History.....	15

1. Specifications

- › Memory: 3.9MB (more than 9 hour record with 0.1s sample rate, logging altitude, global position, ground speed)
- › Sample time: 0.1 – 25.5s (user selectable in 0.1s steps)
- › Dimensions: 29 x 22 x 11mm
- › Weight: 9g
- › Power supply range: 4 – 12.6V
- › Integrated pressure sensor for altitude measurements
- › Logging:
 - Global position
 - Altitude
 - Ground speed
 - RC Input
- › Telemetry support for Jeti Duplex EX®, Multiplex® M-Link, Graupner® Hott, Futaba® SBUS2*, FrSky® S.Port*
- › Upgradeable firmware
- › [Altis Flight Manager](#) software for OS Windows

* only with [Telemetry Converter](#)

2. Introduction

The AerobTec Altis GPS is a telemetry and recording device with integrated GPS receiver and barometric altimeter. It is designed especially to record the altitude and the coordinates of the R/C aircraft during its flight with telemetry support. The unit has very small dimensions and a low weight.

The Altis GPS calculates trajectory coordinates of the aircraft. It also senses barometric pressure variations caused by altitude changes of the aircraft. These data are stored in the internal memory of the device.

3. How does it work

The Altis GPS uses a GPS receiver with a built-in antenna. Unit is able to get a fix in less than 35 seconds in the case of cold or warm start. In the case of hot start the required time reduces to less than 1 second.

The location accuracy of the unit is smaller than 2.5m and the speed accuracy is lower than 0.1 m/s. These values are reported for open space. In order to improve the resolution of altitude and vario measurements, Altis GPS is also equipped with fast modern digital pressure sensor. This sensor enables to sense very small pressure differences. This gives the unit an altitude resolution below 0.5m with sample rates as low as 0.1s. Since the atmospheric pressure changes over time, these changes will affect your

measurements. For this reason, long term measurements may not be precise enough. However, the altitude of short term flights, which are typical for R/C aircrafts, can be recorded very precisely. The measured parameters is stored in the high capacity internal memory which allows approx. 9 hours of recording with the fastest sampling rate (0.1s).





Backup Firmware	No Fix	Logging data	Do not disconnect	USB Mode
 No flashing	 No flashing	 No flashing		

Fig 1: Flashing modes of LED diodes

After the Altis GPS is connected to a power supply, the process of initialization starts and continues until it gets a fix. During the initialization process a yellow LED diode flashes slowly. When the Altis GPS gets a fix, it measures the reference altitude and temperature. Subsequently a yellow LED diode flashes in faster rythm. **Note: It is recommended to set the reference for both altitude and global position before each flight. This can be achieved by setting reference using the RC Input or by disconnecting and reconnecting the power supply.**

4. Hardware description

Connectors of your Altis GPS

Your Altis GPS has 3 connectors. They are shown in Fig 2.

- USB micro – Connects the Altis GPS to a computer via USB
 - RC IN – Molex connector for connection with the free PWM channel of R/C receiver .
 - COM – Molex connector for connection with telemetry equipped receivers.
- Both RC IN and COM connectors can be used for connection with power supply too.



Fig 2: Connectors of your Altis GPS

Wire color	Signal
brown	Ground
red	Positive power supply
orange	R/C signal

Table 1: Colors of the connector wires

Mounting to the aircraft

Since the Altis GPS uses atmospheric pressure for its measurements and receives radio signal, it has to have open access to the outside atmosphere. It must not be completely sealed inside the fuselage or elsewhere. Since most of the standard R/C aircrafts are not fully sealed, it is usually not necessary to do any special modifications for installation. The Altis GPS can simply be put in a free space inside the fuselage. Also it is necessary to keep top side of the Altis GPS directed to the sky and not cover it under conductive surface (metal, carbon fiber etc.)

If the unit is mounted outside the aircraft, the location must be carefully considered. The unit must not be mounted close to the airflow caused by the propeller.

Avoid mounting your Altis GPS to parts of the plane that may become hot during operation.

Connection

Connection for data logging only

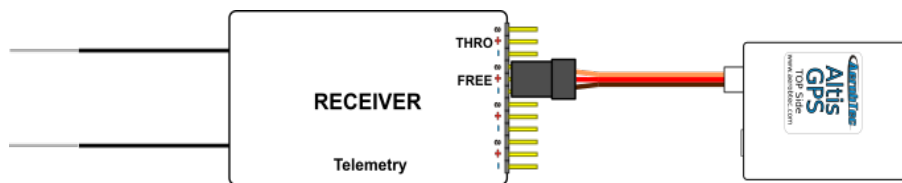

Fig 3: Connection scheme for data logging only (FREE - free receiver channel)

If the Altis GPS device is used solely as a logging device, connect the device to any free receiver channel as shown in Fig 3. The signal polarity must be observed as shown in Table 1.

Connection for telemetry

Some radio systems provide telemetry functions. These functions allow wireless transmission of certain data from the aircraft during the flight and display it on your Tx or monitor screen. The Altis GPS has COM connector reserved for this purpose. Use a Molex/JR telemetry cable (sold separately) to connect your Altis GPS to the telemetry input of your receiver. See Fig 4.

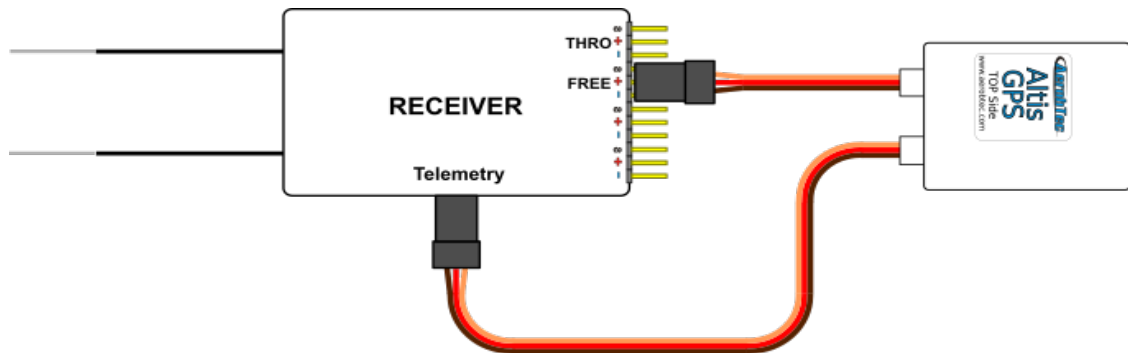

Fig 4: Telemetry connection

USB connection

If you wish to download your logged data to a computer or to change the settings of your Altis GPS, connect the Altis GPS using a standard micro USB cable (sold separately) to a computer with Windows XP (or newer) operating system. See Fig 5. When you connect your Altis GPS for the first time, the computer should install the drivers automatically. You need to have Altis Flight manager program installed in your computer in order to display any stored data or in order to make changes to your settings.

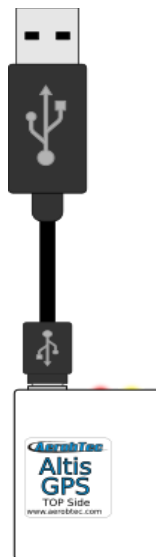

Fig 5: USB cable connection

Do not disconnect

When logging data, there are times when it is dangerous for the device to be disconnected. If the Altis GPS is disconnected at these times, there is a danger of losing all your data in the device. This is indicated by a short flash of a red LED diode during permanent flashing of a yellow LED diode. See Fig 1.

5. Working with the Altis GPS in the Altis Flight manager

The AerobTec Flight manager (AFM) is a PC application for OS Windows which allows you to communicate with Altis GPS and other devices made by AerobTec and to display and process the flight data recorded by them.

AerobTec Flight Manager can be downloaded from <http://www.aerobtec.com/products/rc-electronics/altis-flight-manager>

Note: There is a separate manual for AFM. However, the following pages describe how to set up your Altis GPS in accordance with your needs.

In order to connect the device click **Tools -> Device** (Ctrl + D) or the Device icon on the toolbar. A window will appear. See Fig 6. Choose Altis GPS. AFM automatically connects to your Altis GPS then. If there is more than one Altis GPS connected to your computer, you will be asked to choose which one you wish to connect. When connected, Altis GPS screen window will be displayed.



Fig 6: Device choosing window

Altis GPS window

There are two parts of the window. The upper part shows general information about the device – its firmware version, serial number and memory used.

The bottom part of the window is used for settings.

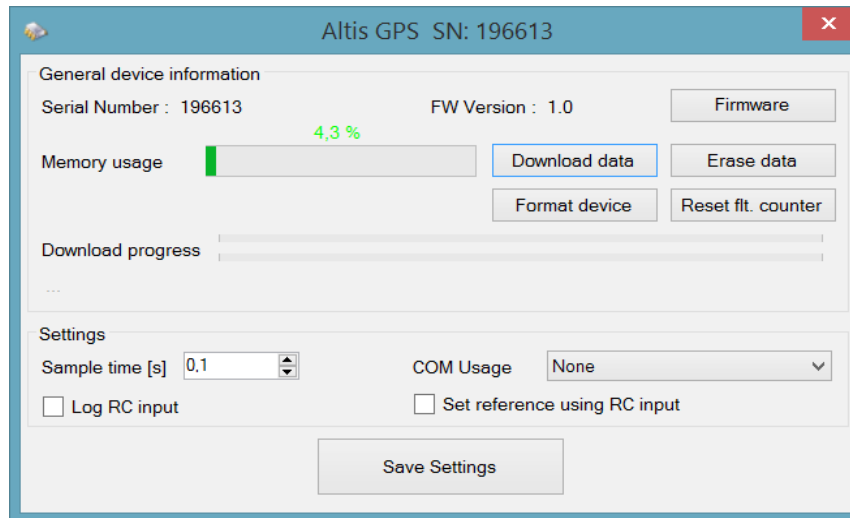

Fig 7: Altis GPS window

Example of use: In case you possess an RC transmitter with Multiplex M-LINK telemetry link and want to use the Altis GPS as a telemetry sensor, it is necessary to select „Multiplex_MSB“ from the „COM Usage“ combo-box.

Downloading the data

In order to access the logged data from your Altis GPS, use the **Download data** button. Once the data is downloaded, you can close the Device window and work with the data.

Erasing data

In order to erase the logged data from your Altis GPS, use the **Erase data** button.

Formating device

In order to format Altis GPS memory into factory settings, use the **Format device** button.

Reseting flight counter

Altis GPS is counting flights so saved log files are with unique number. In order to reset this counter and to start counting log files from zero again, use the **Reset fit. counter** button.

Warning: When the previous procedures are done, it is necessary to use “Safe remove hardware” when disconnecting from the computer. This does not apply when disconnecting and reconnecting your Altis GPS in order to format the memory of your device or in order to reset the flight counter. It only applies to subsequent operation.

Settings

There are basic configurations of the Altis GPS. You can set your Altis GPS according to your needs. This is done by using the settings items in the bottom part of the window.

The **sample time** determines how frequently the parameters will be logged. However, there is enough memory to log about 15 hours of data when logging almost all available parameters with a sample time of 0,1s.

RC Input - PWM input signal from the receiver. You can set if you wish to store the RC Input signal to your device memory or not.

Com port – You can assign a function for the selected port. Currently there are telemetry or live output options. This port is reserved for other future uses.

Available settings for (firmware 1.1) COM are described in table below.

COM
None - inactive
JETI Model Duplex EX
Multiplex MSB
Live Output – for online output of measured data
Graupner HOTT – behaves as Electric Air Module
Futaba SBUS2 with Telemetry Converter
FrSky Sart Port with Telemetry Converter

Table 2: COM A and COM B settings

Set reference using RC Input

You can enable the function which sets reference data of your current location. It is shown on relative parameters – the altitude and distance/trip.

The procedure of setting the reference point is shown in Fig 8. The steps are as follows:

1. Set the value of the PWM input signal to the RC IN port lower than 1000 us.
2. Set the PWM input signal higher than 2000 us immediately after the first step.
3. Hold the value in step 2 for 2-8 s.
4. Change the value of the PWM input signal to the RC IN to less than 1000 us after a while.

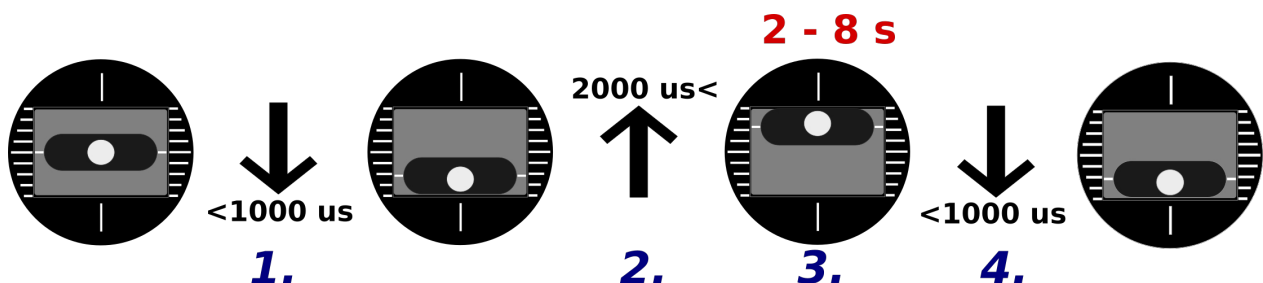

Fig 8: Procedure of set reference

Example of use: The level of PWM signal is assigned to the free channel of your receiver and is activated by a switch on your RC Transmitter.

Firmware upgrade

While your computer is connected to the Internet and the AFM is connected to the Altis GPS at the same time, the AFM compares the firmware version of your Altis GPS with the newest currently available firmware and offers to update the latest firmware for your Altis GPS if necessary. To upgrade the firmware follow the steps below :

1. Click the **Firmware** button
2. Choose the firmware from the list.
3. You can choose a different firmware from a file stored in your computer.
4. After the firmware is selected, click the **Upgrade** button and follow the instructions on the screen. They will guide you through the upgrade.



Fig 9: Firmware upgrade window

Firmware types

The Altis GPS contains only “Standard” Firmware which enables changes of settings.

Backup firmware

If the firmware update fails or if the process is interrupted, the device tries to update the firmware again until it is successful. Once finished, your Altis GPS appears in the computer as a USB removable device again.

If this does not happen or if the first start up of the new firmware is not performed from USB, a safety function is activated and a backup firmware is written to your Altis GPS.

Note: This state is indicated by alternating long and short duration flashes of a red LED diode. See Fig 1.

In this case, follow the firmware update instructions to update a new, valid firmware.

Map View

The Map View is a new feature in the AFM which provides a 3D view of your flight. It is based on the coordinates recorded during the flight via the Altis GPS. It is not available for other Altis Devices. The value of the absolute altitude may have offset with regards to different terrain levels. The Map View tab is displayed only when working with the GPS records.

The view of the flight is composed of permanent and optional elements. See Fig 10.

Permanent elements

These elements are used when fast loading of maps from the Internet is needed. In case of a slow Internet connection, it is recommended to use only the permanent elements.

Terminal marks – These marks show the start and the end of the record containing the local time data.

Trajectory line – The line describes the actual trajectory of the aircraft.

Optional elements

The optional elements increase the amount of transferred data, therefore it is advisable to use only a broad-band connection to the Internet.

These elements are accessed by clicking on **Graph->GPS Trajectory ...** These are the optional elements:

Trajectory wall – A wall that connects the terrain with the altitude line.

Speed points – A group of points whose color corresponds with the speed of the aircraft at that point. The range of speed changes dynamically from flight to flight, hence the value of speed is described in the legend which varies.

Plane mark (Direction) – Markers that continuously show the direction of flight.

Pedestrian mode – This mode attaches the flight to the terrain level.

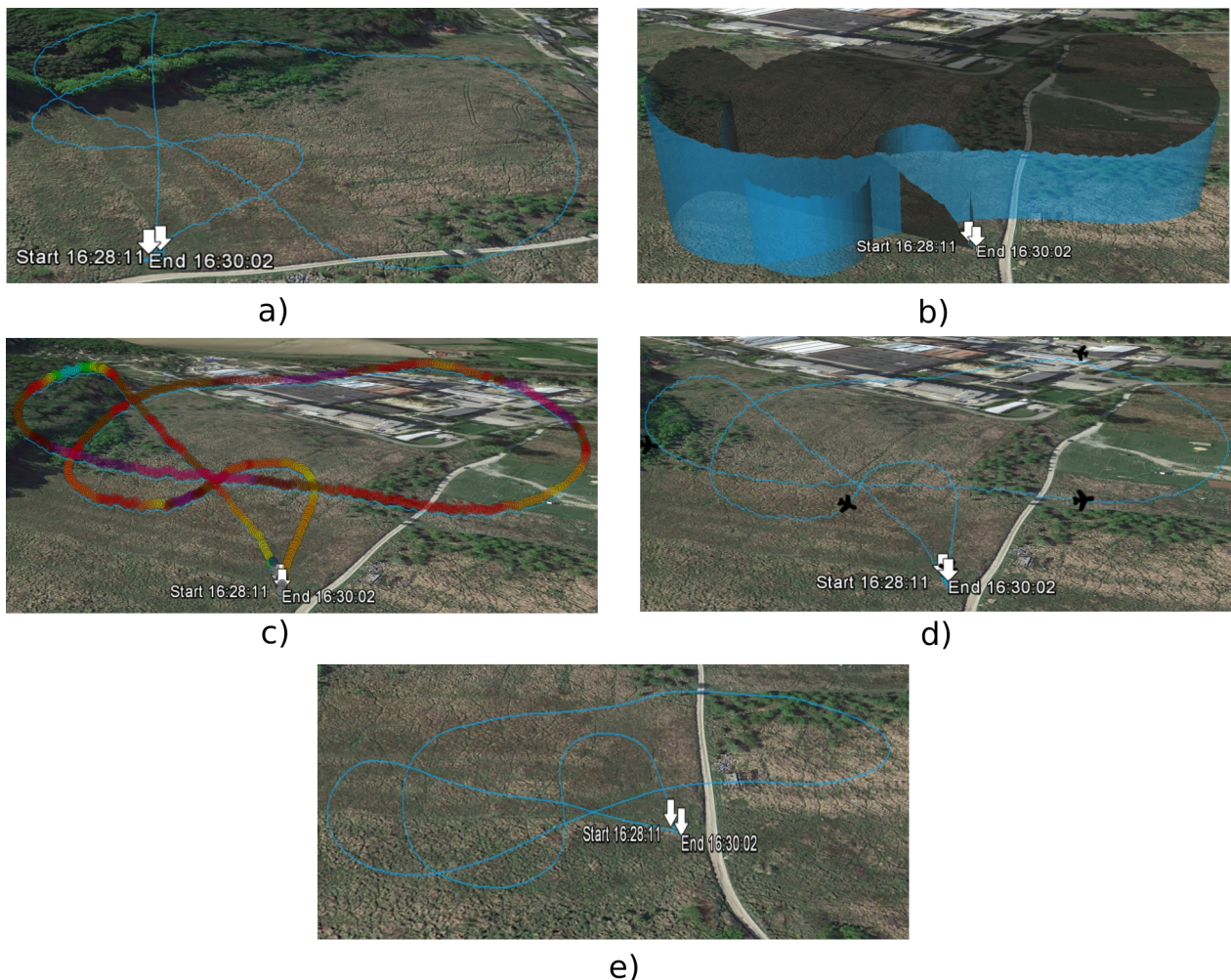

Fig 10: Map View items a)only permanent b)with trajectory wall c)with speed points d)with plane markers e)with pedestrian mode

Warning: For proper functioning of the Map View, it is necessary to have available internet connection. It also requires a Google Earth Plug-in. See Fig 11. The download and installation message appears when the Map View is viewed for the first time and Google Earth Plugin is not presented. After the installation, it is necessary to restart the AFM. In the case of an Internet drop-out, the maps cannot be displayed. In order to display maps, a browser based on Internet Explorer is used.

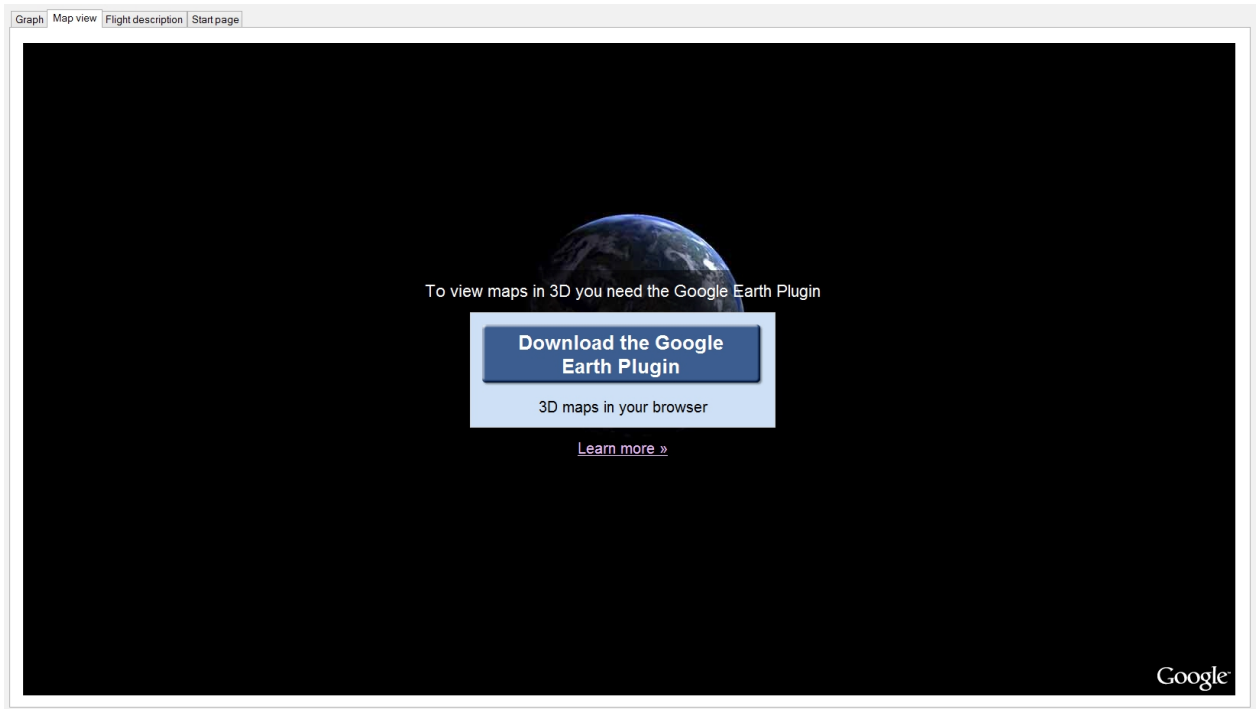

Fig 11: First open of Map View tab with link for download Google Earth Plug-in

6. Warning

Do not mount the Altis GPS device to aircraft components which may be hot while operating (ESC, batteries)!

Do not put the Altis GPS device on metal surfaces, as this may lead to short circuit of the power supply and the RC system may fail.

Do not put the Altis GPS in water, fuel or other liquids!

Before flying with the Altis GPS, always perform a range check!

Do not disconnect the Altis GPS when the red LED diode flashes fast. It is not recommended to write any of your own files or directories to the Altis GPS when it is shown as a removable drive in your computer. This may lead to the corruption or loss of any data on the device.

7. Frequently asked questions and troubleshooting

1. I updated my Altis GPS and it does not function anymore. It was OK before.

Probably, the process of the firmware update was not done properly. Connect your Altis GPS to the computer and wait. In about 30 – 150 seconds it should appear on the PC as a disk drive. If a yellow LED diode flashes alternately short and long period, a backup firmware is probably active and you should run the firmware update again. When a new version of firmware becomes active, the update is finished (the activation is indicated by a flashing yellow LED diode). Otherwise run the update again.

2. I see the altitude on the graph increasing to several meters during a test on the ground. Is the Altis

GPS broken?

No. The barometric pressure depends on the weather. Weather changes can sometimes cause variations of the measured altitude (these variations may be calculated in metres).

Another cause may be that the Altis GPS is overheated. Do not put the Altis GPS near hot objects in the fuselage.

3. A flashing yellow LED diode changed its frequency of flashing from fast to slow.

The GPS receiver of the device lost fix due to the insufficient amount of satellites in the sky or due to the interference of the signal with an object or terrain or another signal. After losing fix, the Altis GPS does not store new samples to its memory. It is necessary to wait until the conditions for the device improve or until the device is moved to another place. After getting a new fix, the newly acquired data will be stored in the same record.

8. Correct disposal of this product



This product should not be disposed with other household wastes at the end of its working life. To prevent possible harm to the environment or human health from uncontrolled waste disposal, please separate this from other types of wastes and recycle it responsibly to promote the sustainable reuse of material resources. Household Users should contact either the retailer where they purchased this product, or their local government of fice, for details of where and how they can take this item for environmentally safe recycling.

Business users should contact their supplier and check the terms and conditions of the purchase contract.

This product should not be mixed with other commercial wastes for disposal.

9. Product Registration

If you did not purchase the product directly from AerobTec please mail following information to sales@aerobtec.com. By registering your products you will be informed about updates and notifications.

Name :

Address* :

Country :

Phone* :

Email :

Product :

Serial number of product :

Date Purchased :

Where did you purchased your product? :

* this information is not obligatory

An alternative option is to register at <http://www.aerobtec.com/support/products-registration>

10. Notes

- > This manual is based on firmware version 1.1 and Altis Flight manager version 4.0.1.
- > Note – Altis GPS was partially developed using Atollic TrueSTUDIO®

11. Revision History

Rev. 1.0. (April 2015)

- Initial release